

## James Heal Martindale Options

In addition to the various tools available for the Martindale, customers can preselect from a range of options for our 2 and 5 station models, to enable us to build an instruments to meet their own specific testing needs.

Ideal for research and development institutions and for companies who do not have a recognised test method for their product.

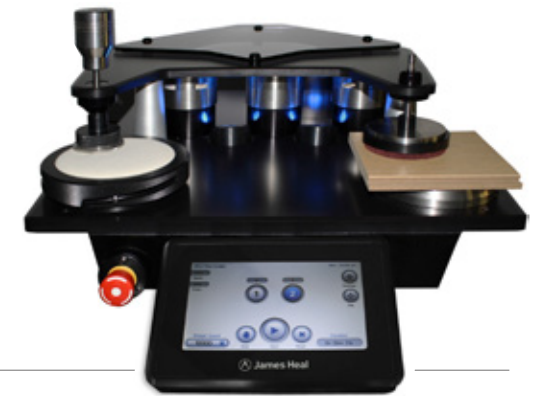

## Wet & Damp Testing

### WATER BATH

For products for which the performance standard requires the sample to be tested wet or damp such as footwear, waterproof garments and water-resistant garments.

Can also accommodate testing if there is a requirement for the product to be fully submerged. The bath is equipped with a hose and a valve to enable easy drainage.

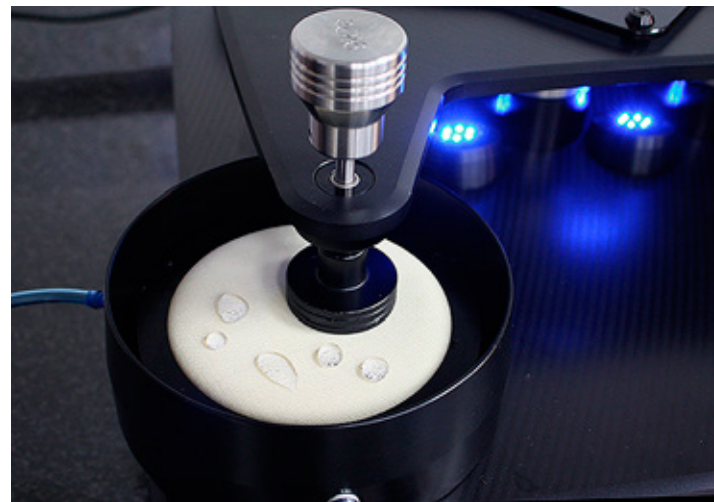
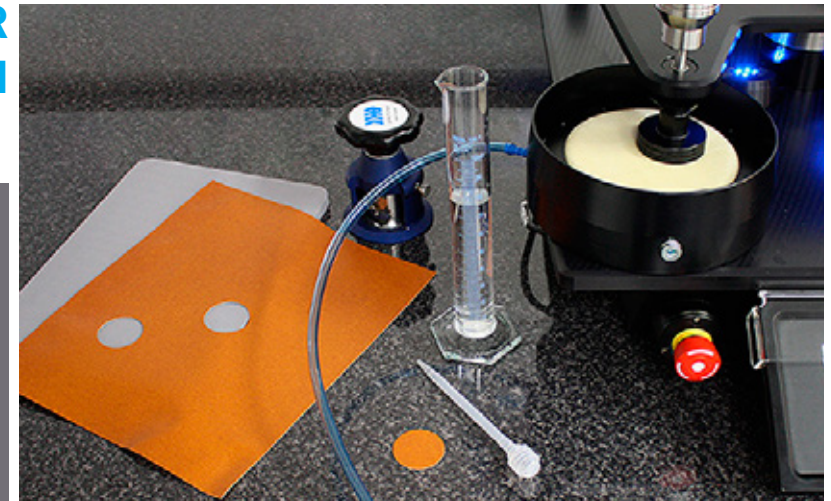

## James Heal Martindale Options

In addition to the various tools available for the Martindale, customers can preselect from a range of options for our 2 and 5 station models, to enable us to build an instruments to meet their own specific testing needs.

Ideal for research and development institutions and for companies who do not have a recognised test method for their product.

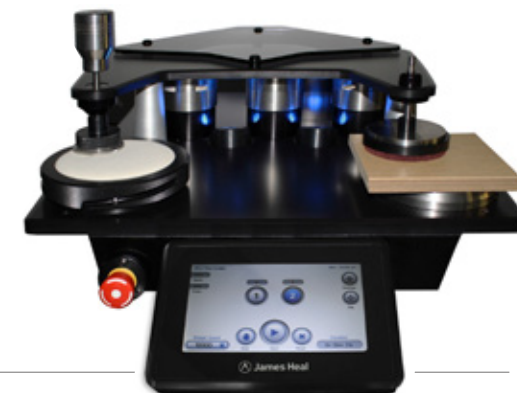

# Textile Testing

FOR A WIDE RANGE OF MATERIALS

Incredibly versatile and with a lissajous motion ideal for testing many different products in the apparel and textile sectors, e.g. garments, socks, upholstery, gloves, collars & cuffs and non-wovens.

A Martindale can be ordered with one station set-up to test fabrics and textiles, and the other station to a one of the other single station options.



## James Heal Martindale Options

In addition to the various tools available for the Martindale, customers can preselect from a range of options for our 2 and 5 station models, to enable us to build an instruments to meet their own specific testing needs.

Ideal for research and development institutions and for companies who do not have a recognised test method for their product.

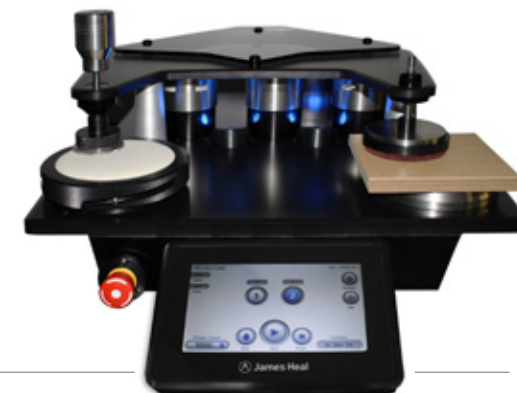

## Straps, Ropes & Shoelaces

### BELT & CORD TABLE ASSEMBLY

Designed to test the abrasive properties of multiple types of cord and belting including shoelaces, rope, cord, straps, cables, tape, webbing and belts.

A table is attached across both stations onto which plates are fitted. These are grooved to hold the sample in place and once in place, the sample is clamped ready for testing. A dead weight tensioning system activates a micro-switch to stop the instrument if the sample breaks.

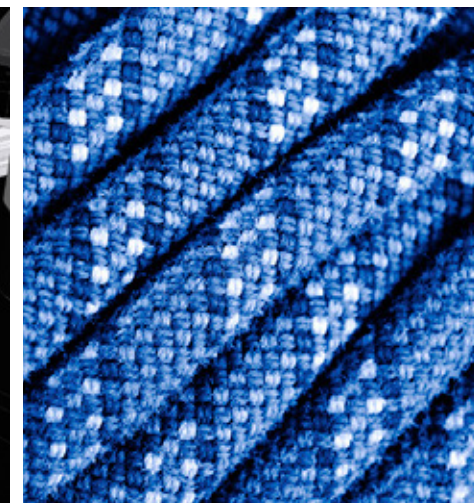
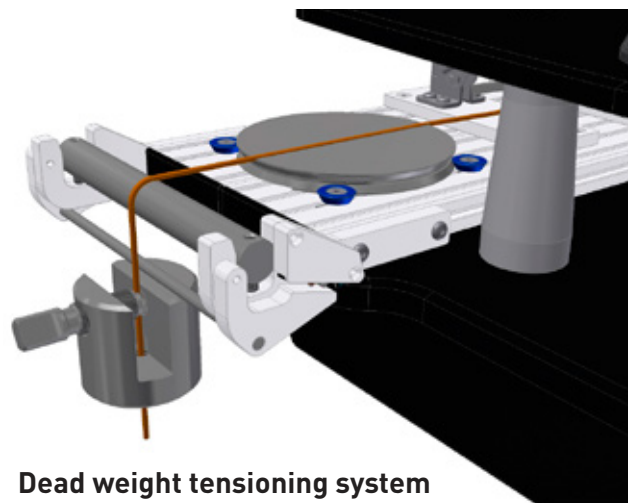

## James Heal Martindale Options

In addition to the various tools available for the Martindale, customers can preselect from a range of options for our 2 and 5 station models, to enable us to build an instruments to meet their own specific testing needs.

Ideal for research and development institutions and for companies who do not have a recognised test method for their product.

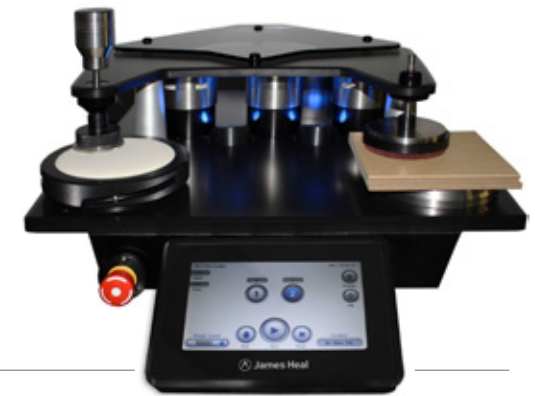

# Thick Samples

## CARPETS AND OTHER MATERIALS

This option enables tests for the resistance to abrasion of thick samples to be undertaken on products such as carpets, leather, shoe components and vinyl.

We offer a choice of abrasives such as rubber sheet or hexapod studs as specified in ISO 10361. We have two different testing options for thick samples; ISO 10361 and EN1813.

